

SERVICE MANUAL

VERTICAL-TYPE BOTTLE COOLERS



Related Models:

M185	MS185	M205		

Contents

1. Safety precautions and recommendations
2. Technical Specifications
 - 2.1 General product appearance and specifications
 - 2.2 Electrical parts and specifications
 - 2.3 Temperature control and adjusting
3. Product labelling and descriptions
 - 3.1 Type label and descriptions
 - 3.2 Serial number expansion
 - 3.3 Product model name expansion
4. Product Assembly and Disassembly
 - 4.1 Lighting Disassembly
 - 4.2 Cooling and Electrical parts assembly and disassembly
 - 4.3 Evaporator-Fan-Thermostat Disassembly
 - 4.4 Roller replacement disassembly
 - 4.5 Rollbond-Fan-Thermostat Disassembly
 - 4.6 Door removal
5. Power cycle diagram
6. Product failure
 - 6.1 Device is not working or not cooling
 - 6.2 Cooling system troubleshooting
 - 6.3 Device runs loudly

Safety precautions and recommendations

1. Deep freezer/ Cooler is set for 220-240 V 50 Hz network power. Use of incompatible voltage may cause deep freezer to become inoperable or fire.
2. Do not place the deep freezer / cooler under direct sunlight or within influence area of a stove, radiator, furnace, oven, heater or infrared. Otherwise, the deep freezer may perform poorly, get damaged or become inoperable.
3. Choose a place without moisture but with air circulation allowed.
4. For your safety, in order to eliminate the risk of electric shock and fire there must certainly be a breaker system with a residual current device in your electrical wiring.
5. After putting the deep freezer into place, allow at least 2 hours without moving it before starting to use.
6. Installation, placement, maintenance and cleaning of your freezer should be as written in the manual.
7. Avoid any sharp and pointed object or overheated material from contacting with glass surface of glass-cover products as this may cause the glass to crack or break. (The option of glass cover may vary as per model.)
8. In order to avoid your appliance from sliding or overturning, place the appliance on a non-tilted flat surface.
9. Never use your freezer with an extension cord or multi socket.
10. Do not clean your device with pressurized water. Pressurized water might damage inner surface, outer surface and electrical equipment of your device.
11. Black wired condenser on the back of the device must absolutely be cleaned and purged against dust once a year. Cleaning might be performed with a vacuum cleaner.
12. Do not allow children to get into the product or play around it.
13. If your deep freezer is equipped with a lid lock, keep your deep freezer locked and keep the key in a safe place beyond reach of the children. By the product's end-of-life, the lid lock of your deep freezer should be rendered ineffective before disposing. Do remember not to leave children in the deep freezer. Staying in the deep freezer may create a life threatening condition.
14. For your safety, in order to eliminate the risk of electric shock and fire there must certainly be a breaker system with a residual current device in your electrical wiring. Our company is not responsible for failures and losses which might occur as a result of using the product in an ungrounded network.
15. Do not use any object except ice scraping apparatus provided with your product to scrape ice off. Using sharp, pointed and metal objects

may damage the interior wall of your cooler/ freezer. This kind of improper use may cause gas leakage.

16. Avoid any sharp and pointed object or overheated material from contacting with glass surface of glass-cover products as this may cause the glass to crack or break. (The option of glass cover may vary as per model.)

17. In case of any failure within your product, taking measures for food preserved within the deep freeze is fully under responsibility of the user. Our company is not responsible for spoiled food due to any technical failure or misuse. 18. The appliance should not be used by physically, visually, audibly or mentally handicapped ones, children, non-experienced or non-informed ones without surveillance of a person responsible for the safety of such people.

19. Open the cabinet door only when necessary. Please make sure that the door is sealed properly when it is not necessary.

20. In the event of a sudden power outage unplug your product. Plug back in 20 minutes after you make sure that the mains become normal.

21. Do not put domestic or wild animals inside your product or allow them to get in. These kind of living creatures might damage the electrical system and cause fire.

22. Loading food in pieces, making additions as food starts to freeze instead of filling your freezer to its full capacity is a healthier freezing method. Since sufficient air flow can not be provided in loadings to the full capacity in one time, cooling process of your freezer might not be sufficient.

23. Do not let the food you recently put in your freezer be in contact with frozen foods.

24. Frozen inner surface of your device or frozen products should not be touched with wet hands. If touched, bonding might occur and might cause injuries.

25. Do not place explosive or flammable material in your deep freezer.

26. The device is not to be used with purposes other than it is intended (food storage) for commercial purposes, for example; cooling water, cooling fizzy or fizzless beverages in a bakery oven.

27. Your device is manufactured for home use and it's not appropriate to use it in commercial areas with a commercial purpose. Failures which might occur as a result of this type of usage is not covered in the warranty disclaimer.



Attention!

- **This appliance includes inflammable and explosive gas R600a or R290.**
- **The ventilation holes on the casing or the body of the appliance shall be kept open to prevent blocking**
- **Do not use mechanical tools or other mechanisms except the ones recommended by the manufacturer to make defrosting quicker.**
- **The cooling circuit shall not be damaged.**
- **Except materials recommended by the manufacturer, no electric appliances should be used within food storage compartment of the appliance.**
- **In order to decrease the risk of ignition, this appliance shall only be installed and maintained by services.**

2. Technical Specifications

2.1 General product appearance and specifications

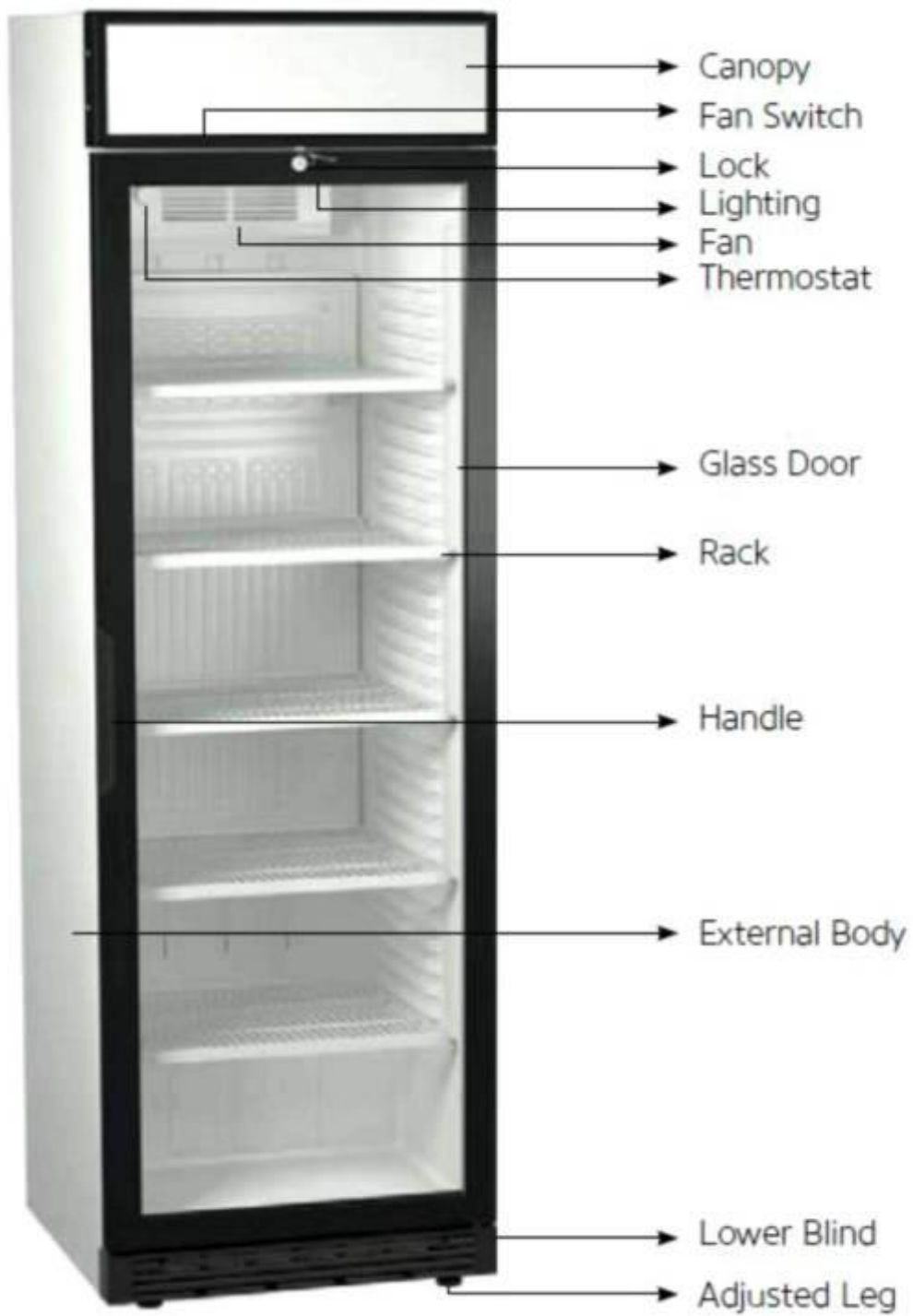

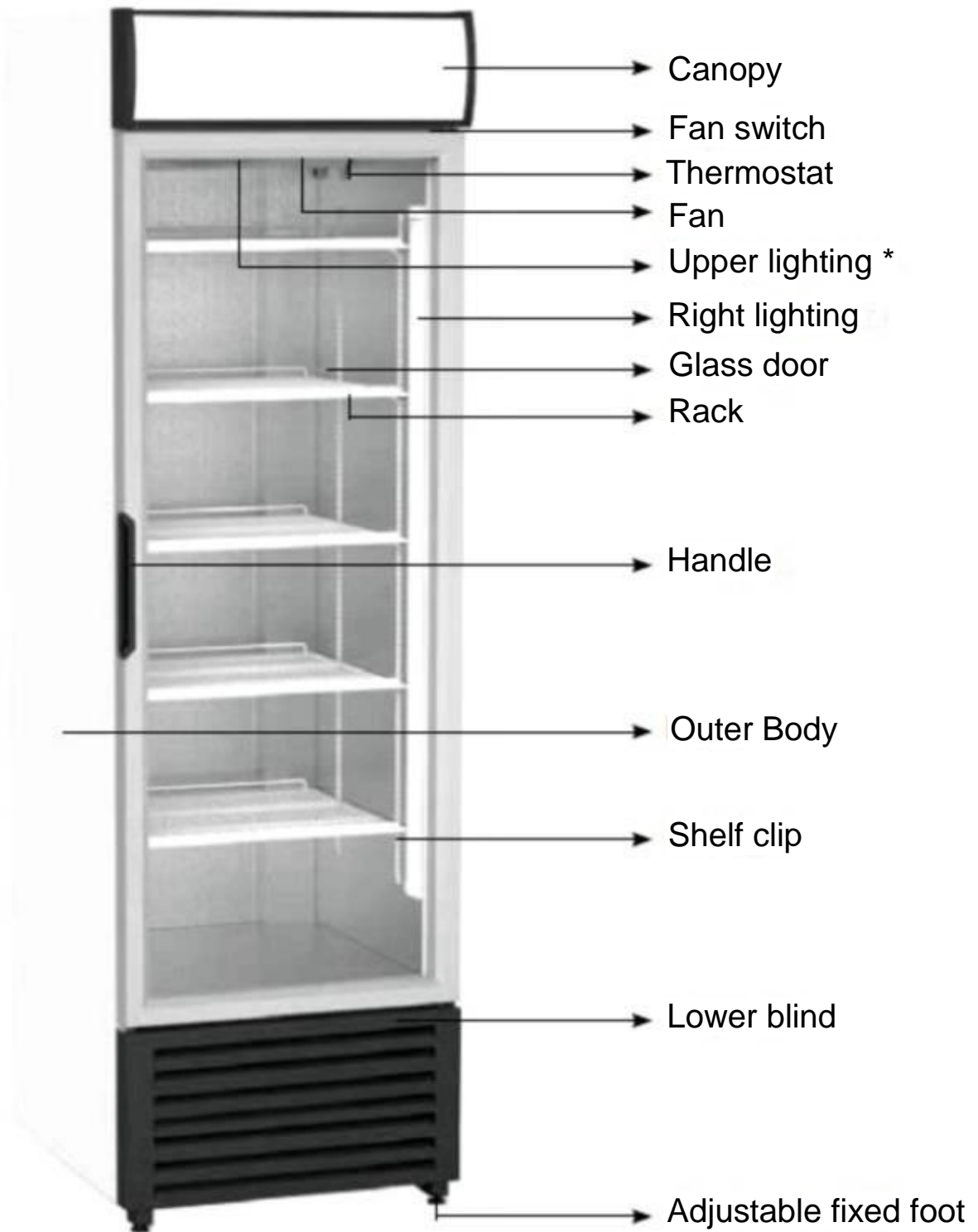

2.2 Compressor Models That Use Electrical Cooling Parts and Specifications

COMPRESSOR MODEL	MOTOR TYPE	OIL TYPE	COMPRESSOR WINDING		STARTING RELAY	OVERLOAD THERMAL	OVERLOAD THERMAL POWER OFF TEMPERATURE (°C) (°C)	OVERLOAD THERMAL POWER ON TEMPERATURE (°C)	CAPACITOR
			MAIN WINDING (Ω)	AUXILIARY WINDING (Ω)					
EMBRACOEMY3118Y	RSIR	Mineral, 150ml	15.03+/-8%	15.23+/-8%	PTC GROUP 230V	AE19BU8	18.1+7%	25.7+7%	NONE
JIAVIPERATT1117GY	RSIR	Mineral, 160ml	18.1 +7%	25.7+7%	QP3-15/C	B62-120	61+9	120+5	NONE
CUBIGELNLYSORAa	CSIR	ISO VG 32 ESTER, 400cm ³	8.62	12.15	2014149.	T0266	52.00	105.00	64- 77 uF 330 V
CUBIGELNLY12RAa	CSIR	ISO VG 32 ESTER, 400cm ³	5.45	8.72	2014158.	T0188	61.00	115.00	72- 88 uF 330 V
CUBIGELNPT14RA	CSIR	ISO VG 32 ESTER, 400cm ³	4.50	5.75	2014166.+ NTC150	MRA38134 T0348	52.00	105.00	64- 77 uF 330 V 16 uF 420V

Compressor
connection
Jiaxipera model:

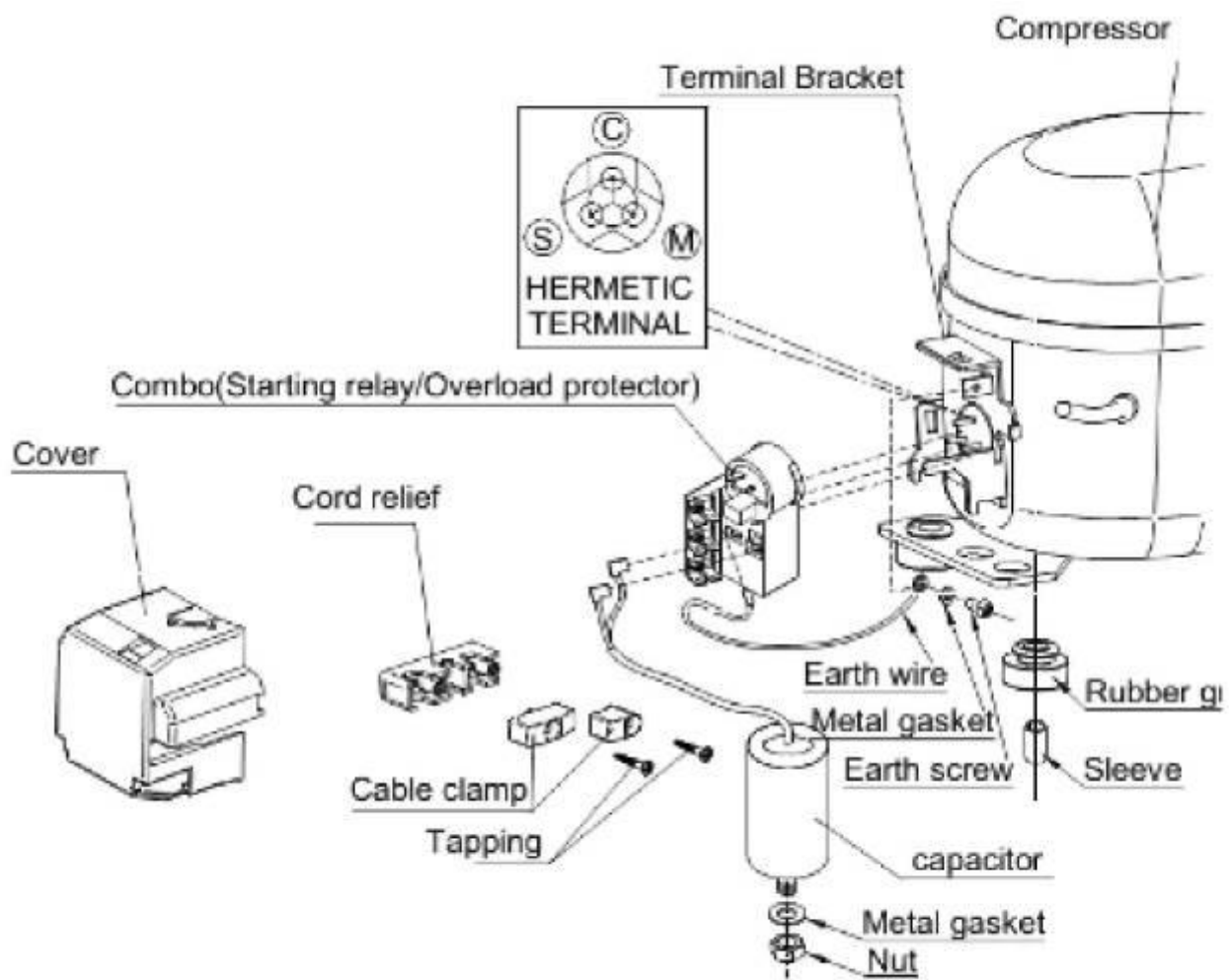

Compressor
connection
Cubigel model:

WIRING DIAGRAMS AND ELECTRICAL ASSEMBLY

CSIR CONNECTION (L, P ranges)

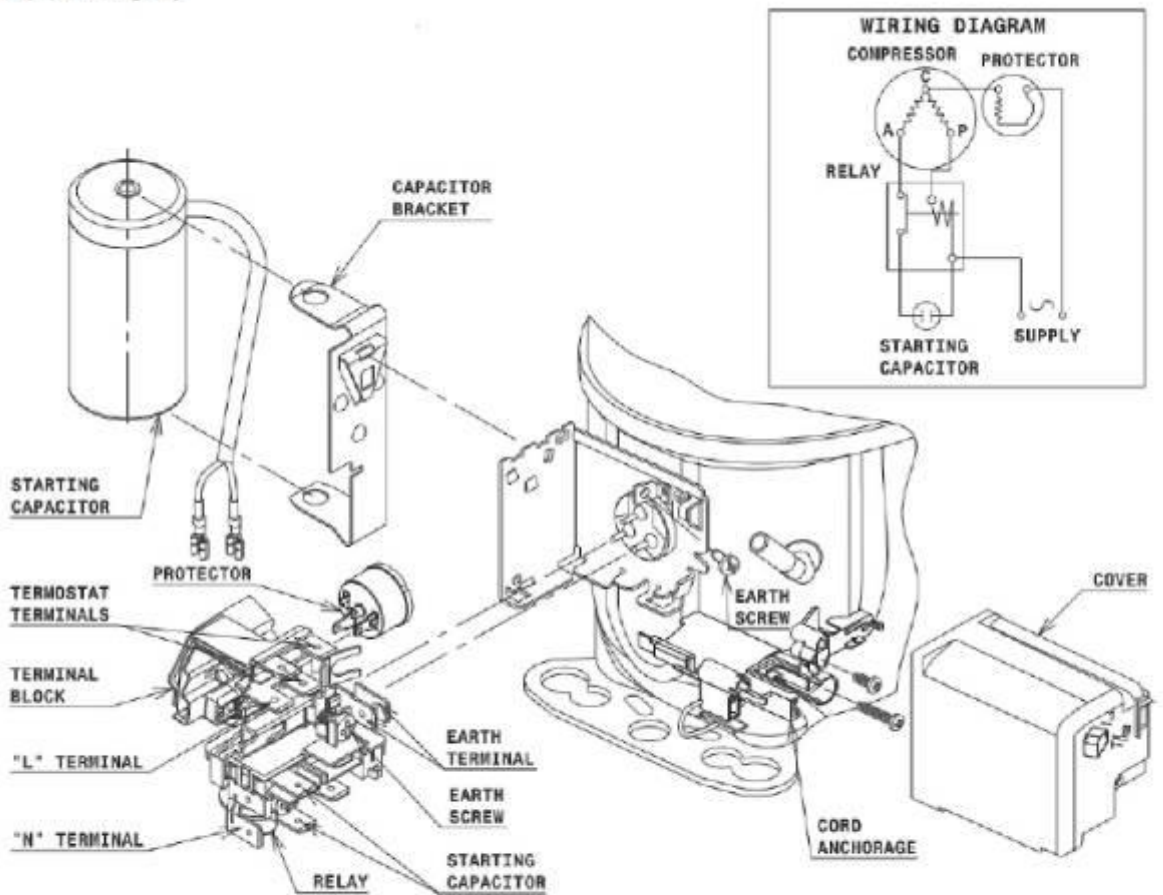

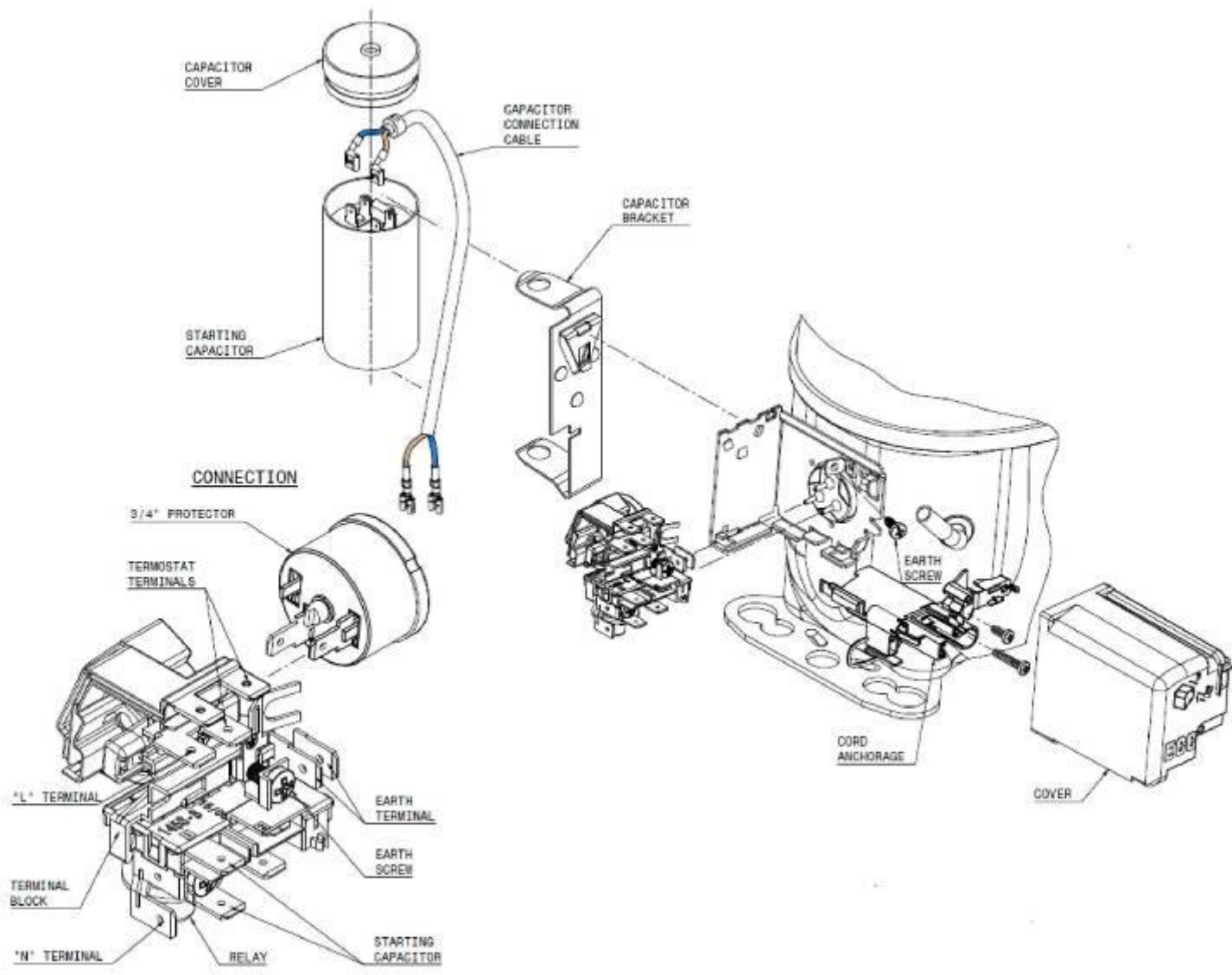

Compressor connection
Embraco model (EMT,NEU):

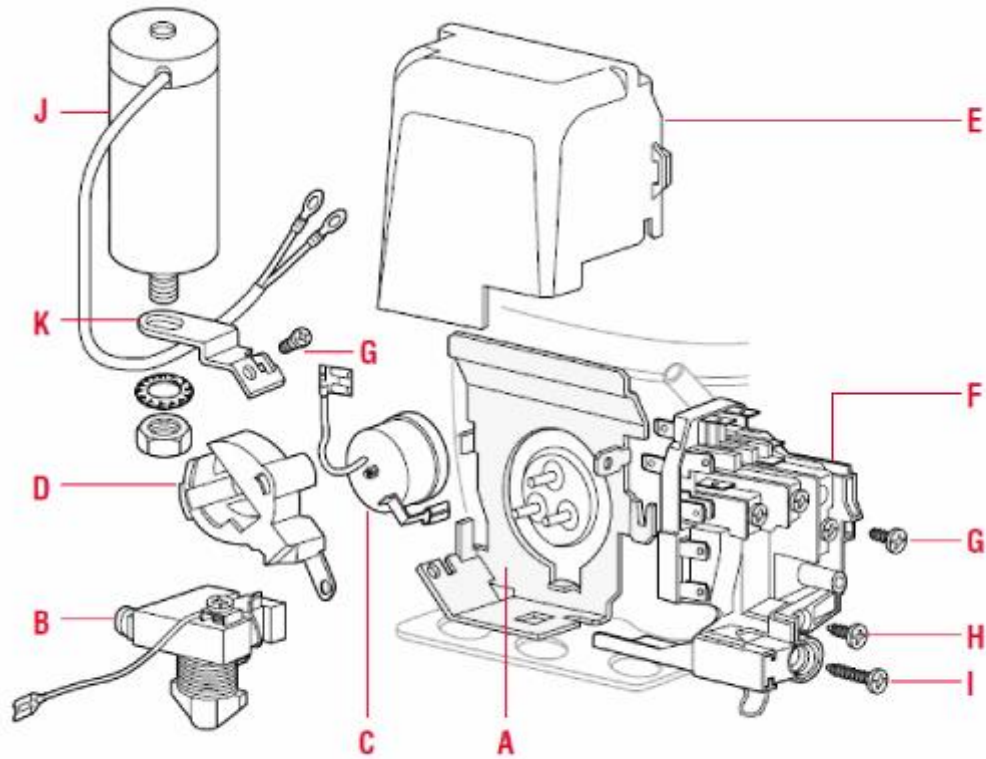

- A : Compressor
- B : Relay
- C : Thermal
- D : Thermal protection-connection cover
- E : Terminal housing protection cover
- F : Terminal connection kit
- G: M3,5x7 capacitor bracket connection screw
- H: M4 x 11 cable holder plastic screw
- I: M4 x 21 cable holder plastic screw
- J: Capacitor
- K : Capacitor bracket

Connection Type

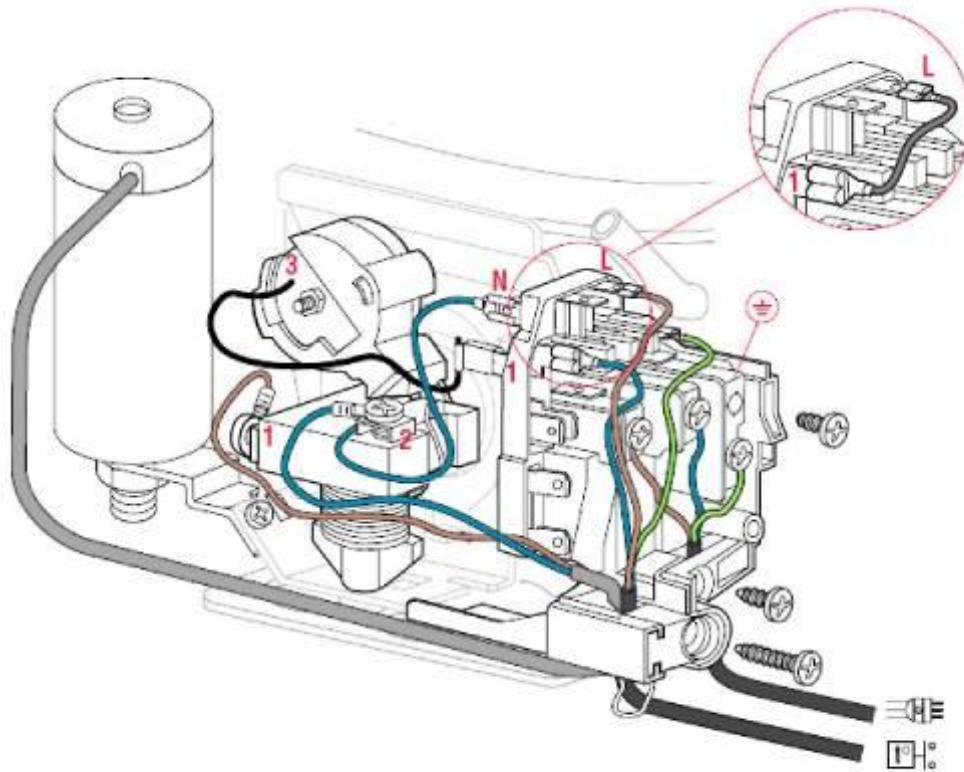

Compressor Connection

Embraco model (EMY):

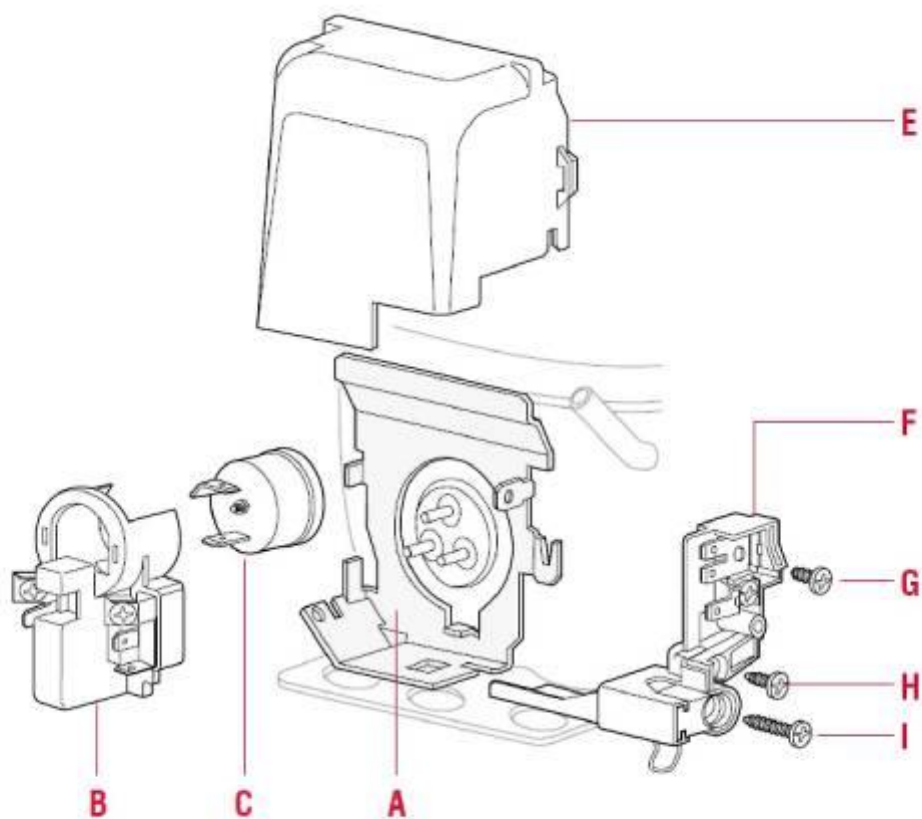

A : Compressor

B : PTC take-off relay

C : Thermal

E : Terminal housing protection cover

F : Terminal connection kit

G: M3, 5x7 connection screw

H: M4 x 11 cable holder plastic screw

I: M4 x 21 cable holder plastic screw

Connection type

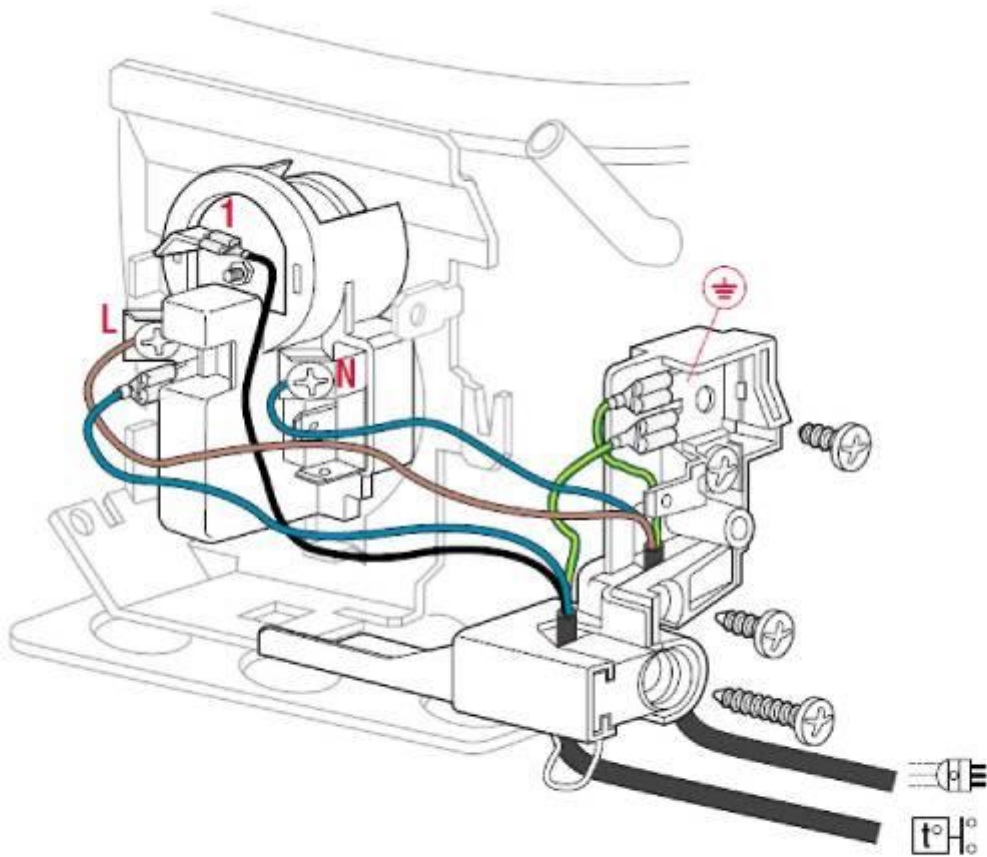

2.3 Temperature Control and Adjustment

Mechanical thermostat model:

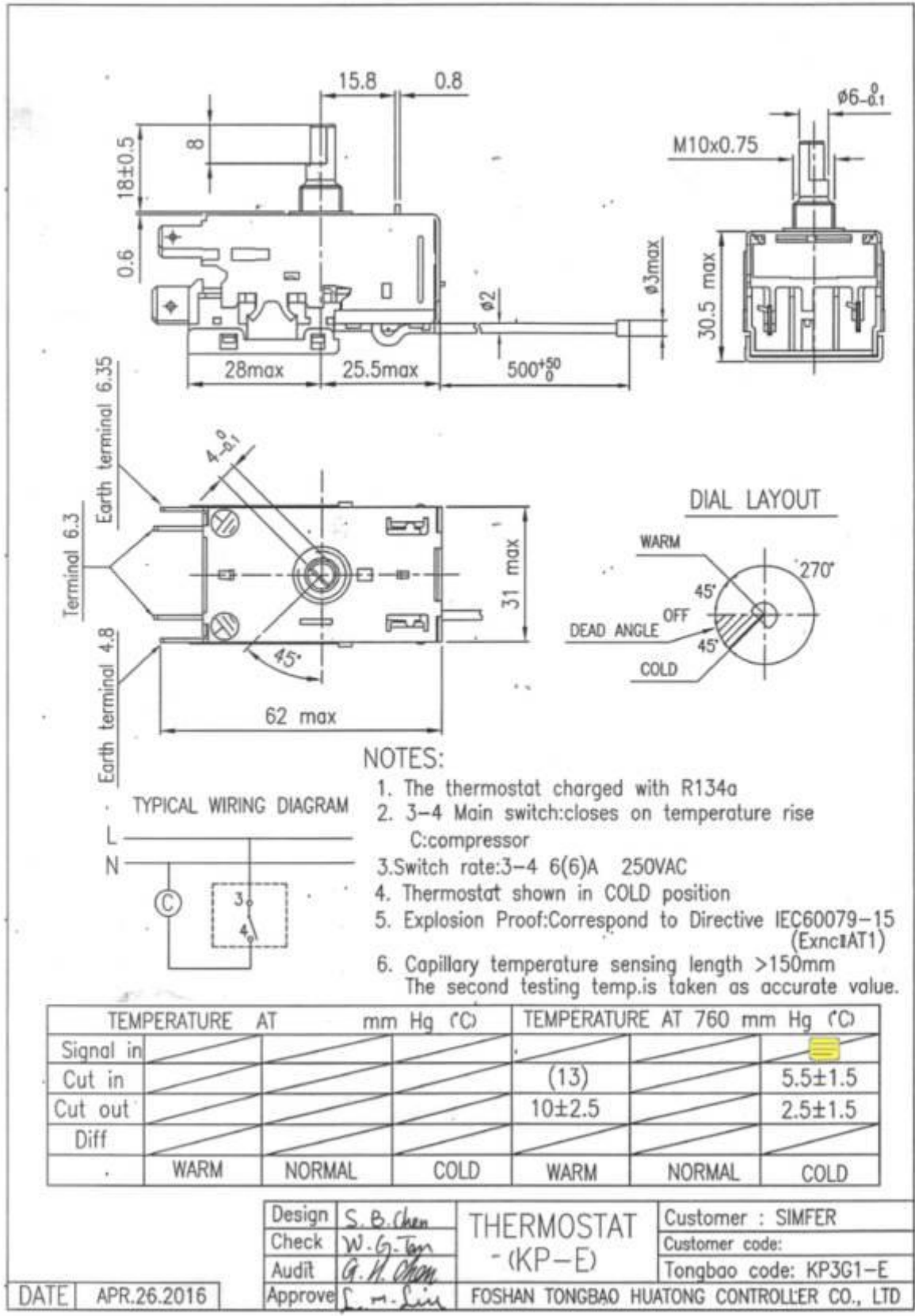

MODES

- a) **1 (Min) position** : keeps the freezer at the hottest value. The inner temperature of the cabin in this mode is around +10°C
- b) **Off Mode:** When the potentiometer is switched to Off by rotating it counter clockwise, cooling system turns off.
- c) **7 (Max) Mode** : In this mode, the freezer continuously operates as quick freezing function. The temperature inside the cabin drops to +1°C and lower levels.

3. Product labelling and descriptions

3.1 Type label and descriptions

1	ÜRÜN STOK NO:	MAC0-2SEWW-CS2160A++-000	TOPLAM BRÜT HACİM:	138 L	14
2	ÜRRETİM KODU:	CS2160A++	SOĞUTUCU NET HACİM:		15
3	MODEL:	10C160ES	DONDURUCU NET HACİM:	134 L	16
4	KONFIGÜRASYON:	900003	DON. GIDA SAKLAMA NET HACİM:		17
5	SİPARİŞ NO:	SSP-001056-3	DONDURMA KAPASİTESİ:	10 kg / 24 h	18
6	MÜŞTERİ NO:	123ABC	SINIF:	SN-T	19
7			SOĞUTMA TEKNİĞİ:	Statik	20
8	VOLTAJ:	220-240 V~			
9	FREKANS:	50 Hz			
10	GÜÇ:	100 W			
11	AKIM:	0.35 A			
12	DEFROST GÜCÜ:				
13	SOĞUTUCU GAZ TİPİ:	R600a			
	SOĞUTUCU GAZ ŞARJ MİKTARI:	30g			
					21

CE TÜRK MALI MADE IN TÜRKİYE

1. Product description code used in factory
2. The code by which we distinguish volume and energy class of home products and export products within Simfer and is also given in the technical table in user manuals. Customer based variation is applicable.
3. Product main model code
4. Short code generated following the selection of options
5. Order number and line number belonging to the order
6. Market code belonging to the customer as per customer demand
7. Permissible operating voltage of the device
8. Permissible operating frequency of the device
9. Value of maximum power used by the device
10. Value of maximum current drawn by the device
11. Out of use.
12. Type of refrigerant in device
13. Quantity of refrigerant in device
14. Total gross internal volume of the device.
15. Out of use.
16. Usable net volume of the device
17. Out of use.
18. Maximum product quantity the device can freeze at a time within 18.24 hours.
19. Climatic classification of the device (SN-T: The device can operate between 10°C and 43°C)
20. The device has a static cooling system. No fan support is provided.
21. Serial number

3.2 Serial Number Expansion







digit	10 0 6 8 6	10 0 10 2	0 2	1 6	0 5	0 2
	Configuration code	Numeric serial no.	month	year	PU facility Automation code	Packaging automation code

3.3 Product model name expansion

SYD 410 MD DC	BRAND	CODE DESCRIPTION	SIMFER CODE
S	S SIMFER	6 IMEER HORIZONTAL FREEZER (-16/-26) 150 CABIN METAL FLAT	SYD 150 MD DC
	PRODUCT CASING	6 IMEER HORIZONTAL FREEZER (-16/-26) 210 CABIN METAL FLAT	SYD 210 MD DC
Y	Y HORIZONTAL	6 IMEER HORIZONTAL FREEZER (-16/-26) 310 CABIN METAL FLAT	SYD 310 MD DC
	PRODUCT TYPE	6 IMEER HORIZONTAL FREEZER (-16/-26) 410 CABIN METAL FLAT	SYD 410 MD DC
D	D FREEZER (-16/-26)	6 IMEER HORIZONTAL FREEZER (-16/-26) 510 CABIN METAL FLAT	SYD 510 MD DC
S	S COOLER (+1/+10)	6 IMEER HORIZONTAL FREEZER (-16/-26) 600 CABIN METAL FLAT	SYD 600 MD DC
D	D MULTIFUNCTION		
	WIDTH CLASSIFICATION	6 IMEER HORIZONTAL COOLER (+1/+10) 150 CABIN METAL FLAT	SYS 150 MD DC
15	15 150 CASING	6 IMEER HORIZONTAL COOLER (+1/+10) 210 CABIN METAL FLAT	SYS 210 MD DC
21	21 200 CASING	6 IMEER HORIZONTAL COOLER (+1/+10) 310 CABIN METAL FLAT	SYS 310 MD DC
31	31 300 CASING		
41	41 400 CASING	6 IMEER HORIZONTAL COOLER (+1/+10) 150 CABIN PLASTIC FLAT	SYS 150 PD PK
51	51 500 CASING	6 IMEER HORIZONTAL COOLER (+1/+10) 210 CABIN PLASTIC FLAT	SYS 210 PD PK
60	60 600 CASING	6 IMEER HORIZONTAL COOLER (+1/+10) 310 CABIN PLASTIC FLAT	SYS 310 PD PK
	FRAME TYPE		
M	M METAL FLAT	6 IMEER HORIZONTAL FREEZER (-16/-26) 150 CABIN PLASTIC	SYD 150 PK
M	M METAL ANGLED	6 IMEER HORIZONTAL FREEZER (-16/-26) 210 CABIN PLASTIC	SYD 210 PK
P	P PLASTIC FLAT	6 IMEER HORIZONTAL FREEZER (-16/-26) 310 CABIN PLASTIC	SYD 310 PK
PA	PA PLASTIC ANGLED	6 IMEER HORIZONTAL FREEZER (-16/-26) 410 CABIN PLASTIC	SYD 410 PK
	COVER TYPE	6 IMEER HORIZONTAL FREEZER (-16/-26) 550 CABIN PLASTIC	SYD 550 PK
D	D SLIDING FLAT GLASS	6 IMEER HORIZONTAL FREEZER (-16/-26) 650 CABIN PLASTIC	SYD 650 PK
B	B SLIDING ROUND GLASS		
SP	SP SLIDING P.U. DOOR		
C	C GLASS DOOR		
PK	PK P.U. DOOR		
O	O OPEN DOOR		
	MECHANICAL FEATURE		
C	C CANOPY		

4. Product Assembly and Disassembly

4.1 Lighting Disassembly

Part Name	How to	Descriptive images
Power LED	Unscrew the screws on the right and left of the power led plastic using a Phillips screwdriver and remove the plastic as shown in the figure.	 
	Disconnect the power LED cable by pressing the connector tab.	
	Power LED plastic is mounted to the plastic with 6 Phillips screws. Remove the power LED using a Phillips screwdriver.	

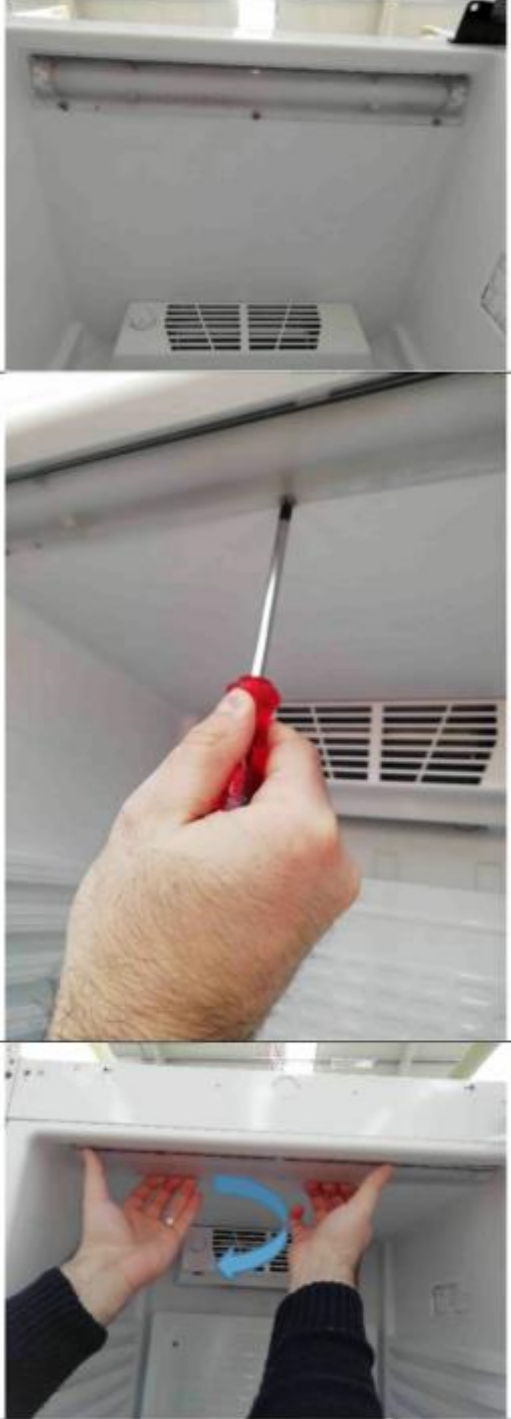
Part Name	How to	Descriptive images
Top-Side LED	<p>Lighting Socket Type</p> <p>Unscrew the upper lighting plastic are using a Phillips screwdriver. Remove the cover manually by holding from its rear and lift it up as shown in the picture.</p>	

Lighting Socket Type-2

Remove the cover retainer plastics on both ends of the lighting socket using a Phillips screwdriver.



Remove the transparent lighting plastic from the upper right and left corners by lifting it up using a flat screwdriver, then pull the cover out.



Remove the LED bar by flexing the LED retainer out manually as shown in the figure.



Disconnect the power LED bar cable on the canopy part by pressing the connector tab.

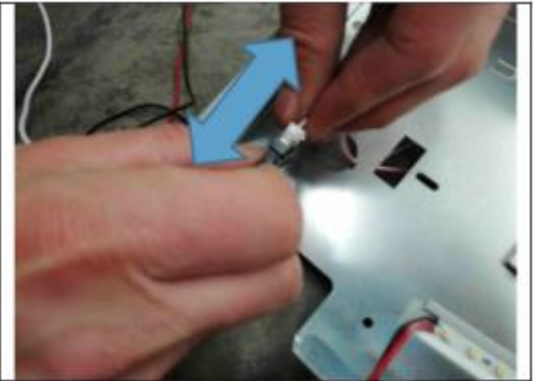

Part Name

How to

Descriptive images

Fluorescent Lighting

To remove the fluorescence out of the socket, insert the flat screwdriver through the front part and then slightly press it upwards. Remove the fluorescence from the lighting socket by holding it from the protruding part.



Pull out the fluorescent lamp socket to remove it from the fluorescence.



Connect the white cables to one socket of the fluorescence and connect the red cables are to the other socket. Press the needle inwards through the opening on the side of the channels where the cables are connected, as you gently pull the cable out.

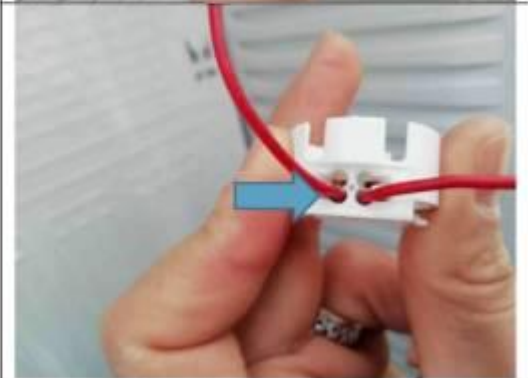



4.2. Cooling and Electrical parts assembly and disassembly



Part Name	How to	Descriptive images
Compressor Electricity Connection	The compressor cover is opened by pressing upwards from the downwards cable connection with a flat screwdriver. (the disassembly of the tab detail is explained on the compressor covers. Differences may occur in compressors with different brands)	

There is a lock mechanism in the terminals connected to the compressor thermal relay. When removing the terminals, the latch, which is indicated with a blue arrow and located in the middle part of the terminal, is pushed downwards and the terminal is extracted.

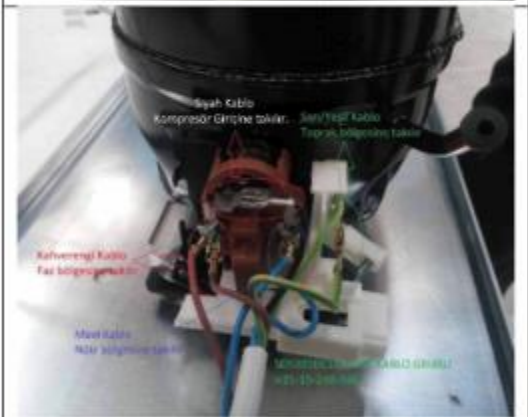
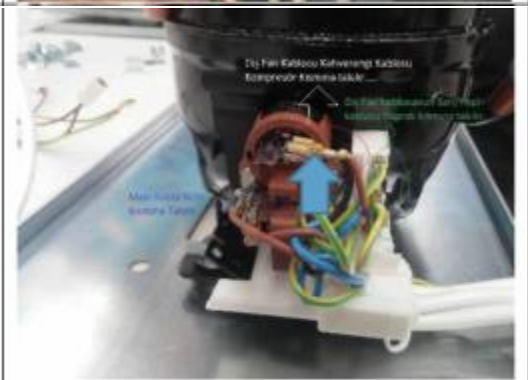
Terminals connected with a screw are disassembled with a cross point screwdriver.

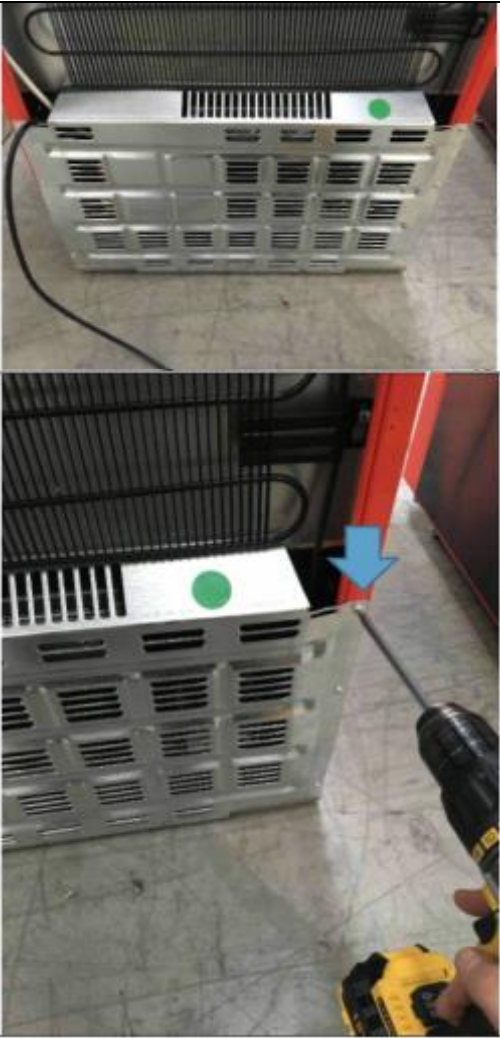

Part Name	How to	Descriptive images
Compressor Cover Plate	Move to the rear of the cabinet to remove the compressor cover plate.	

Part Name	How to	Descriptive images
External Fan	Remove the connectors on the external fan.	
	Remove the screws using a Phillips screwdriver.	 

Part Name	How to	Descriptive images
Gas Replacement (Never use welding or similar material)	Before vacuum charging or pipe replacement, cut the service pipe from a point 2-3 cm away from the weld using a pipe cutter.	

Part Name	How to	Descriptive images
Condenser	Replace the condenser using 7 piece socket wrench set.	



Part Name	How to	Descriptive images
Roll Bond Evaporator	Cut the welds on the compressor and the dryer using a pipe cutter and capillary cutter.	





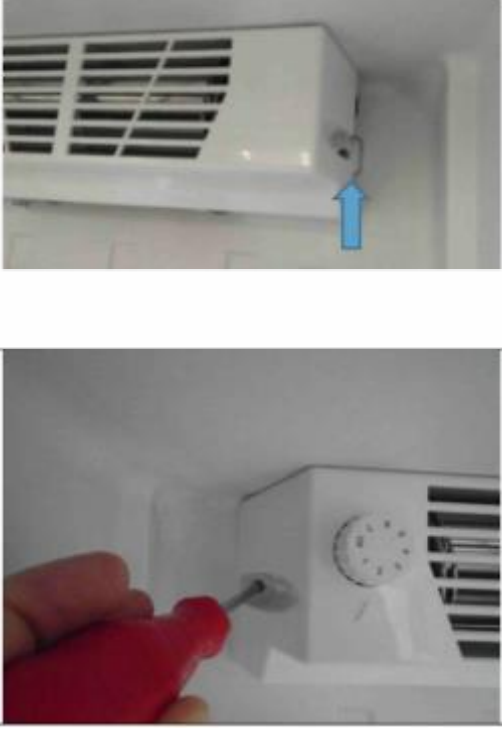



Remove the Roll Bond Evaporator's screws using a Phillips screwdriver.

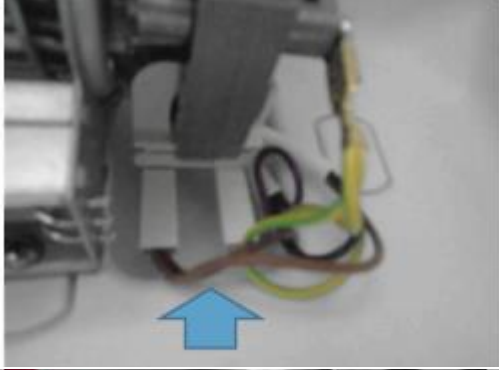







Part Name	How to	Descriptive images
Internal Fan Cover	Remove the internal fan cover using a Phillips screwdriver.	

Part Name	How to	Descriptive images
Thermostat	Remove the thermostat connectors on the removed internal fan cover.	
	Remove the nut on the cover.	

Part Name	How to	Descriptive images
Internal Fan	Remove the connectors on the internal fan.	
	Remove the internal fan using a Phillips screwdriver.	

Part Name	How to	Descriptive images
Compressor	Cut the welds using a pipe cutter.	
	Remove the compressor cover.	
	Remove the connectors.	
	Remove the retaining rings on the compressor.	



Part Name	How to	Descriptive images
Lower Blind	<p>Move to the front of the refrigerator and open the door.</p> <p>Once the door is opened, remove the two screws on the top using a cordless drill or a Phillips screwdriver.</p>	 
	<p>After the screws are removed, remove the lower louver by pulling it out towards yourself.</p>	
	<p>Remove the lower louver.</p>	

Part Name	How to	Descriptive images
Parts on the Compressor Plate	Unscrew the 2 screws on the compressor plate using a Phillips screwdriver or a cordless drill.	
	Lift up the compressor plate is towards yourself and pull it out.	

Part Name	How to	Descriptive images
Gas Replacement (Never use welding or similar material)	Before vacuum charging or pipe replacement, cut the service pipe from a point 2-3 cm away from the weld using a pipe cutter.	

Part Name	How to do	Descriptive images
Condenser	Replace the condenser using 9 piece socket wrench set or 9" socket wrench.	

Part Name	How to	Descriptive images
Fan Assembly	Replace the fan assembly using 9 piece socket wrench set or 9" socket wrench.	

Part Name	How to	Descriptive images
Compressor	When the compressor is being replaced, cut the welds, remove 4 retaining rings. Then	
	insert the flat screwdriver into the tab groove to remove the compressor cover. Push the screwdriver to the right to release the tab to the left.	
	Remove the cover from inside the slide.	

Replace the compressor by removing the connectors.



Part Name	How to	Descriptive images
Discharge Container Adapter Pipe	Before replacing the Discharge Container or Discharge Container Adapter Pipe, cut the Discharge Container Adapter Pipe first with a pipe cutter 2-3 cm away from the welding point and	
	unscrew the fixed sections on the discharge container using a Phillips screwdriver or a cordless drill.	



4.3. Evaporator-Fan-Thermostat Disassembly

Part Name	How to	Descriptive images
Hood	Unscrew the hood using a Phillips screwdriver or a cordless drill.	

Part Name	How to	Descriptive images
Thermostat	The place where the thermostat is installed to the hood is unscrewed using a Phillips screwdriver or a cordless drill.	



Part Name	How to	Descriptive images
Fan Assembly	The fan assembly is unscrewed using a Phillips screwdriver or a cordless drill.	 The descriptive images section contains two photographs. The top photograph shows the interior of a refrigerator with a white circular fan assembly mounted on the ceiling. A blue arrow points upwards towards the fan. The bottom photograph is a close-up of a person's hands using a yellow and black cordless drill to unscrew the fan assembly. The person's left hand is placed on the fan's grille for stability.

Part Name	How to	Descriptive images
Fin Evaporator and Exchanger	<p>Unscrew the rear louver using a Phillips screwdriver or a cordless drill.</p>	 
	<p>Cut the Exchanger Welds at a distance of 2-3 cm from the welded using the Pipe Cutter and Capillary Cutter.</p>	

Unscrew the connection screws of the fin evaporator using a Phillips screwdriver or a cordless drill



4.4. Roller Replacement - Disassembly

Part Name	How to	Descriptive images
Wheel Replacement	Move to the rear of the cabinet in order to remove the compressor cover plate.	 <p>The descriptive images consist of two photographs. The top photograph shows a white metal cabinet with a compressor cover plate on top. A green dot is visible on the cover plate. The bottom photograph shows a close-up of the cover plate being worked on. A hand is using a yellow and black power drill to remove a screw from the cover plate. A blue arrow points to the screw being removed.</p>

Part Name	How to	Descriptive images
Wheel Replacement	Bend the wheel pin fixing tab downwards using a screwdriver.	 <p>The first photograph shows a close-up of a white plastic wheel assembly. A blue arrow points to a small metal tab on the wheel pin. A screwdriver is positioned to bend this tab downwards. The second photograph shows the same wheel assembly from a different angle, with the blue arrow pointing to the tab now bent downwards, securing the wheel pin.</p>

Remove the wheel pin. After that the wheel can be removed.



Part Name

How to

Descriptive images

Install the new wheel and remount the wheel pin.



Part Name	How to	Descriptive images
	<p>Bend the wheel pin fixing tab back to its original position using screwdriver or pliers to secure the pin.</p>	

4.5. Roll Bond-Fan-Thermostat Disassembly

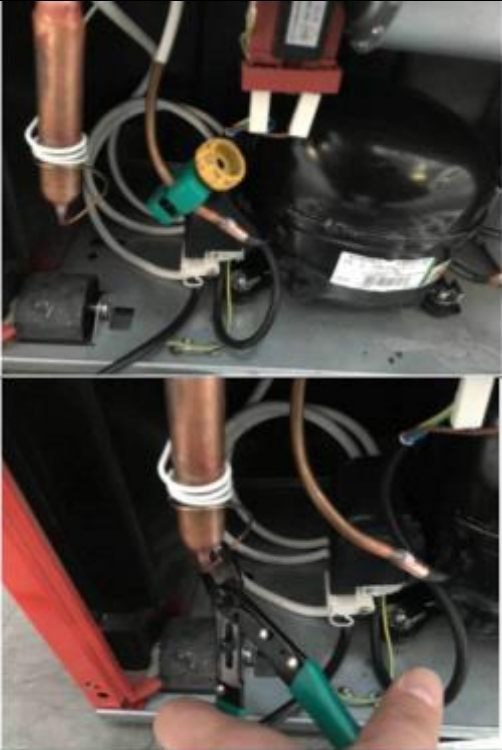
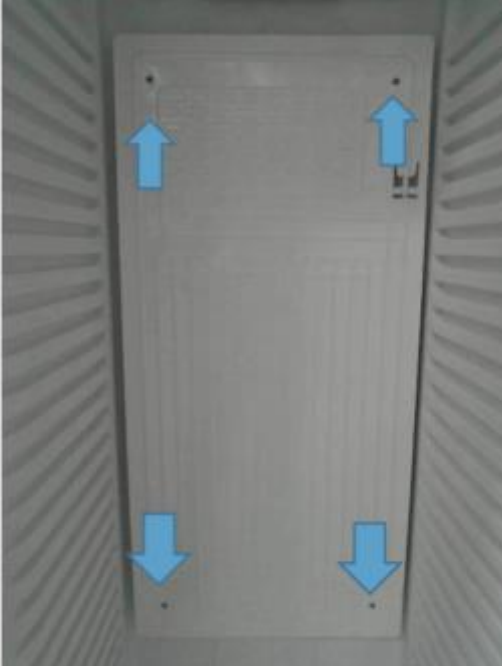
Part Name	How to	Descriptive images
Roll Bond Evaporator	Cut the welds on the compressor and the dryer using a pipe cutter and capillary cutter.	
	Remove the Roll Bond Evaporator's screws using a Phillips screwdriver.	



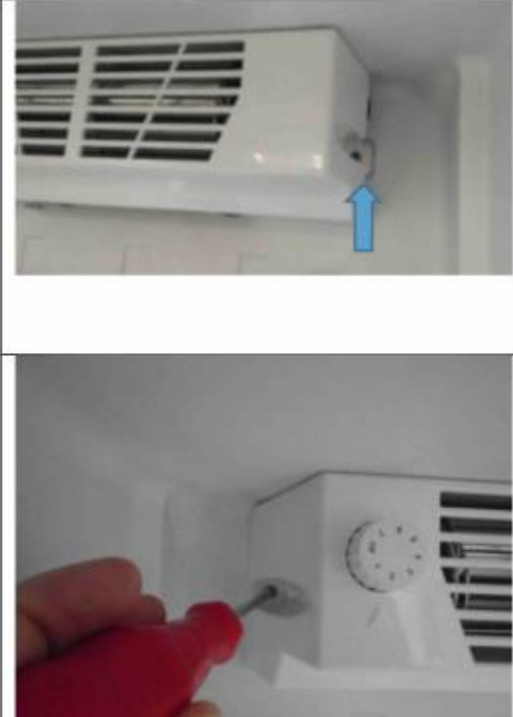

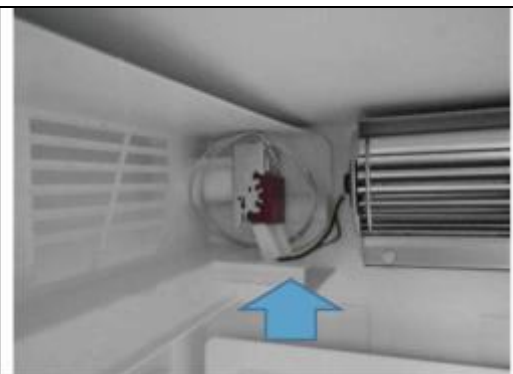
Part Name	How to	Descriptive images
Internal Fan Cover	Remove the internal fan cover using a Phillips screwdriver.	

Part Name	How to	Descriptive images
Thermostat	Remove the thermostat connectors on the removed internal fan cover.	

Remove the nut on the cover.

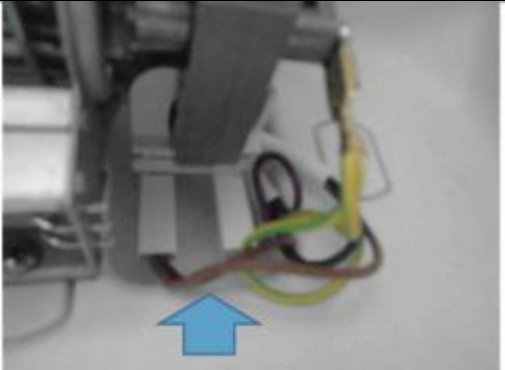

Part Name	How to	Descriptive images
Internal Fan	Remove the connectors on the internal fan.	 A photograph showing the internal fan assembly of a device. A blue arrow points to a specific connector or cable within the assembly.
	Remove the internal fan using a Phillips screwdriver.	 A close-up photograph showing a hand using a red-handled Phillips screwdriver to remove a screw from the fan assembly.

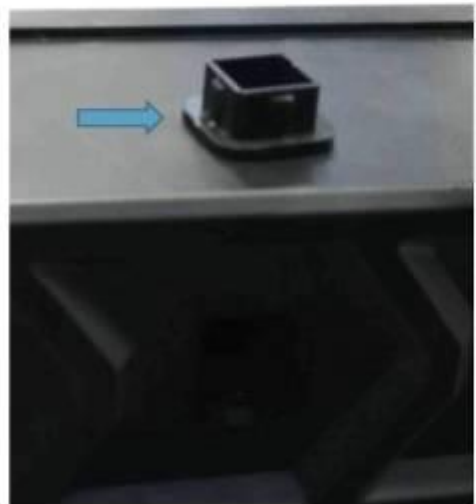
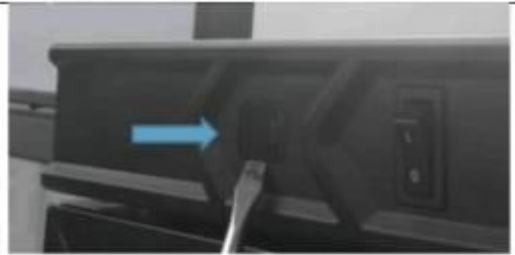

Also remove the control panel connection screws using a flat screwdriver.

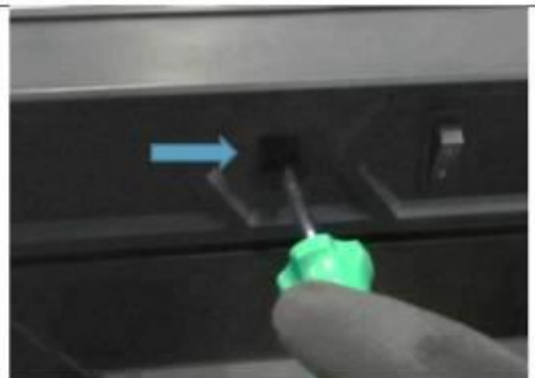

Remove the control panel by pulling it towards yourself.



Place the control panel on the cabinet without damaging the cables.

2. Step

After removing the canopy plastic on canopy products and after removing the control panel on products with control panels, the cocking spring on doors shall be released. This process is not necessary on doors without cocking springs. For doors without cocking springs, the door can be removed by removing the upper hinge first.

In order to release the cocking spring on doors with cocking springs, release the allen-head M4 cock spring bolt using 3 mm diameter hard metal rods or an apparatus that can be inserted into the M4 screw hole of the cocking spring with two pieces of hard-metal tools fitting into a M4 screw hole by turning to the left on doors that open to the right and viceversa. Remove the released M4 cock spring bolt using an allen wrench.

CAUTION!!!

Do not remove the apparatus from the cocking spring that we turned with the help of the apparatus and firmly hold the apparatus. Since the cock spring bolt is removed and the cocking spring is still set, the spring may harm you by ejecting the apparatus. Therefore keep holding the spring. After unscrewing the M4 bolt, insert the other apparatus into the other holes of the cocking spring and turn the spring stepwise in the opposite direction of spring installation to release the cocking spring. When doing this,

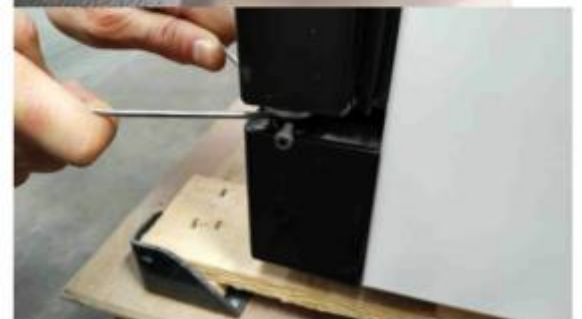

make sure that the apparatus is fully inserted into the holes and that you hold the apparatus firmly.



Release the spring by turning it slowly in the opposite direction of the spring installation.



3. Step
Remove the bolts of the door upper hinge.
CAUTION!!!

When removing the upper hinge bolts, hold the door to prevent it from falling or seek help to hold the door.



There are two types of bolts in the upper hinge: M5 allen-head bolt and M5 bolt.

The M5 allen-head bolt shall be removed with 4 inch allen wrench.

The M5 bolt shall be remove using the T25 torx bit.

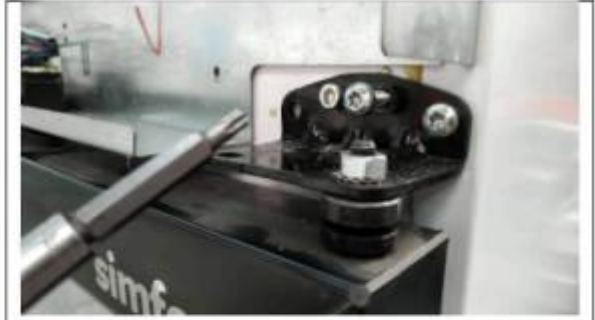

Remove the upper hinge. Remove the door by gently lifting it and releasing the door hinge hole from the lower hinge pin.

Some models products upper hinge is installed as depicted in the side picture. When removing the door on these products, after loosening the cocking spring, the upper hinge shall be removed by removing the M5 torx bolts first as described above. (CAUTION!!! Make sure to hold the door so that it does not fall while removing the upper hinge bolts.)

After the upper hinge has been removed, gently lift the door up to remove it.



4. Step

After the new door is seated on the lower hinge pin, sort the upper hinge on the door and tighten the upper hinge bolts.



5 Step

With the apparatus we use for releasing the spring we can also install the spring. Install the spring by turning it 2 turns to the right for the doors opening to the left and viceversa. Make sure that the apparatus is fully inserted into the holes and that you hold the apparatus firmly in order to prevent the spring from snapping back.



After installing the spring, tighten the cock spring bolt with allen-head M4 bolt.



Then release the spring carefully. Do not remove the apparatus until the bolt touches the stopper

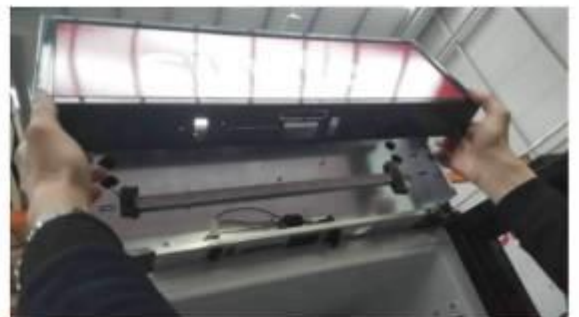

On metal canopy products, place the canopy first.



Tighten the upper and lower connection screws of the canopy.



For products with a control panel, install the the control panel first, tighten the screws and install the screw plugs.



CAUTION: Never interfere with a device filled with R600a and R290 gas with weld. If you are not able to cut the drier inlet pipe, ensure that the gas is discharged by gashing the drier body with side cutting pliers. Then, cut the pipes

M series (LED)

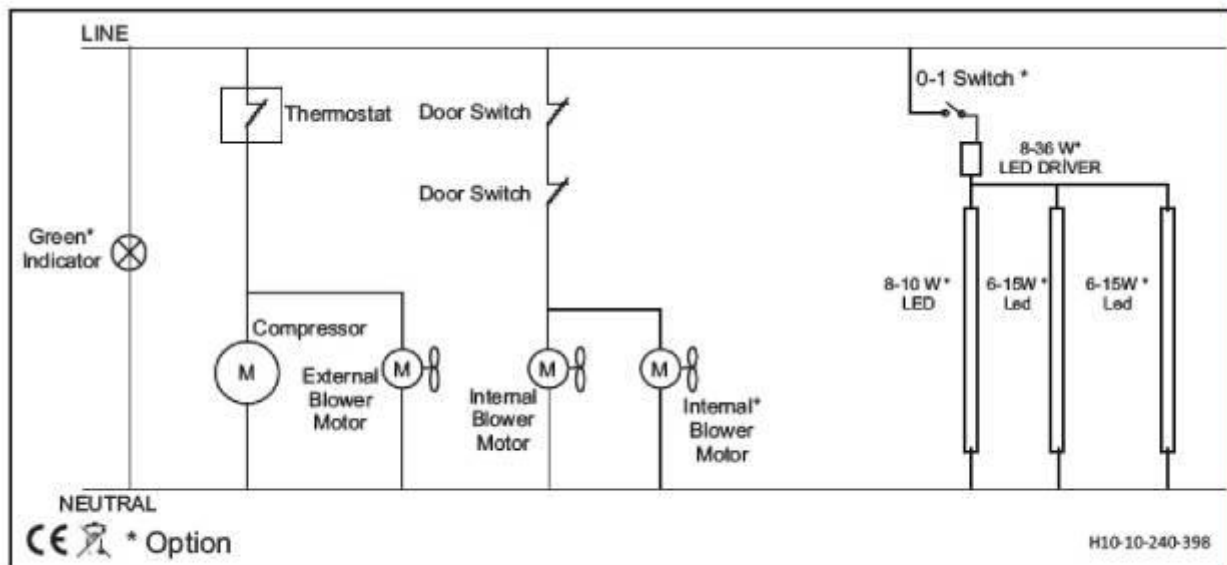

6. Product Failure

6.1 Device is not working or not Cooling

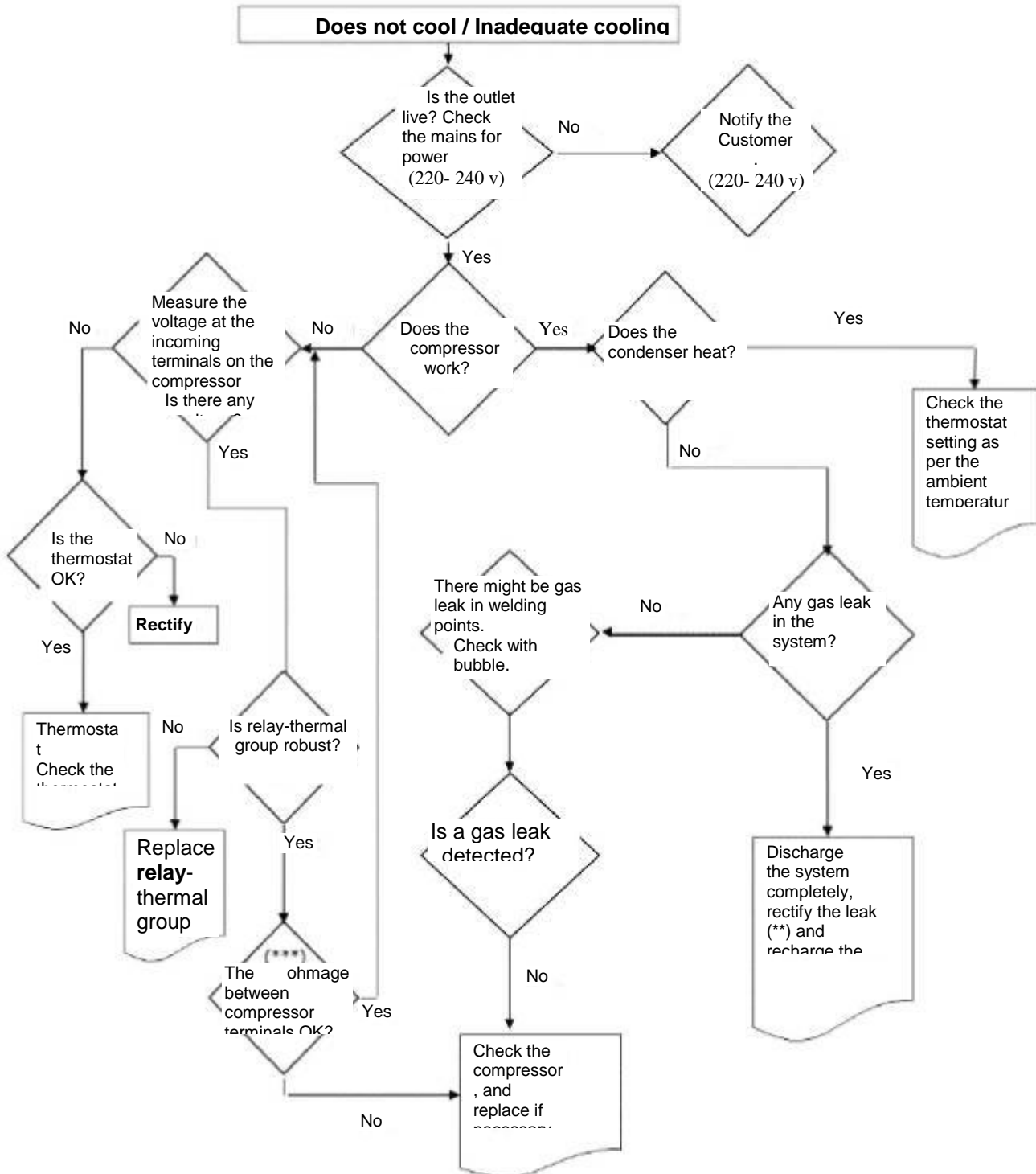

(*) Check whether there is any gas leak in all visible pipe and welding points or not. (**) Before charging gas into the system, replace the dryer and after vacuum at least for 1 hour, charge coolant at an amount equal to the label value. (***) See technical table for compressor winding voltage.

6.2 Device runs loudly

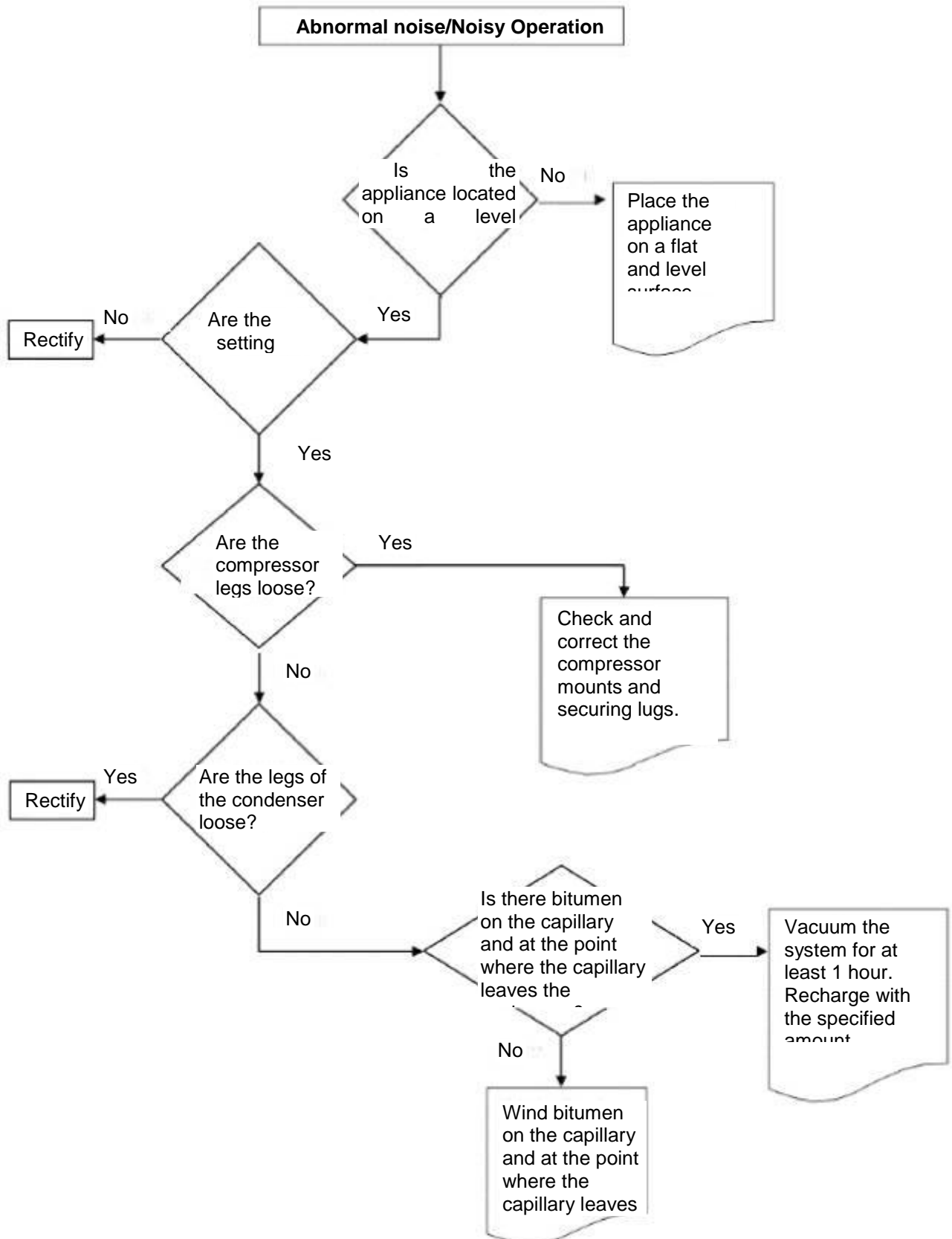

6.3 Cooling system troubleshooting

Symptom	Reason	Remedy
<ul style="list-style-type: none"> • Evaporator cooling decreases but heats up afterwards • Condenser heat is increasing • Operation mode never changes 	System failed due to presence or formation of humidity.	Discharge refrigerant from the cooler. Replace the drier, vacuum and then restore required amount of refrigerant.
<ul style="list-style-type: none"> • Condenser is cold • Evaporator is cold • Compressor is hot 	Foreign substances in the system block the cooling cycle.	Discharge refrigerant from the cooler. Replace the drier, vacuum and then restore required amount of refrigerant.
<ul style="list-style-type: none"> • There is not any temperature difference between return pipe and pressure pipe. • Compressor temperature is at ambient temperature • There is no cooling in evaporator 	Compressor failure	Replace compressor.
<ul style="list-style-type: none"> • Frosting in the return pipe • Condenser is overheated • Evaporator is not working efficient 	Too much refrigerant.	Discharge refrigerant from the cooler. Replace the drier, vacuum and then restore required amount of refrigerant.
<ul style="list-style-type: none"> • Condenser is cold • Compressor surface is too hot • Freezer cooling rate is very slow 	Refrigerant leak (regional icing may be observed on the evaporator.) System failed due to presence or formation of humidity.	Discharge refrigerant from the cooler. Replace the drier, vacuum and then restore required amount of refrigerant.

CAUTION: Always remove the plug of refrigerator before interference. Make sure that refrigerator is deenergized.